

Oven

User manual

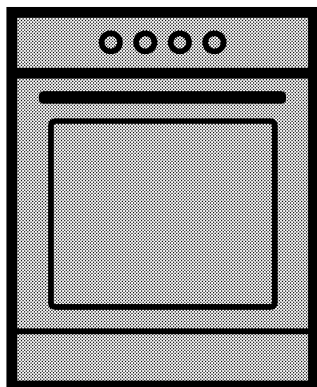

8315
8315 S

EN

285.3037.92/10.10.2016

Please read this user manual first!

Dear Customer,

Thank you for purchasing this Arçelik product. We hope that you get the best results from your product which has been manufactured with high quality and state-of-the-art technology. Therefore, please read this entire user manual and all other accompanying documents carefully before using the product and keep it as a reference for future use. If you handover the product to someone else, give the user manual as well. Follow all warnings and information in the user manual.

Remember that this user manual is also applicable for several other models. Differences between models will be identified in the manual.

Explanation of symbols

Throughout this user manual the following symbols are used:

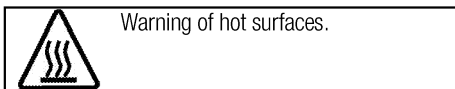
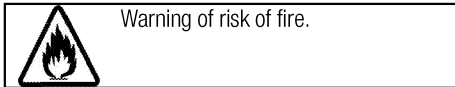
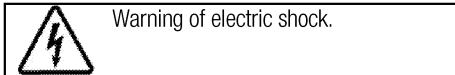
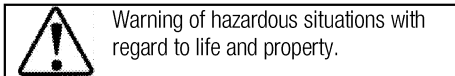
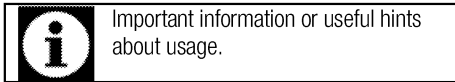

TABLE OF CONTENTS

1 Important instructions and warnings for safety and environment 4

General safety	4
Safety when working with gas.....	4
Electrical safety	5
Product safety	6
Intended use	8
Safety for children.....	8
Compliance with AEEE regulation and disposal of waste products	9
Package information	9

2 General information 10

Overview	10
Package contents	11
Technical specifications	12

3 Installation 13

Before installation	13
Installation and connection	14
Future Transportation.....	16

4 Preparation 17

Tips for saving energy	17
Initial use.....	17
First cleaning of the appliance	17
Initial heating.....	17

5 How to use the hob 18

General information about cooking	18
Using the hobs.....	18

6 How to operate the oven 19

General information on baking, roasting and grilling	19
How to operate the electric oven	19
Operating modes.....	20
Cooking times table.....	20
Making yogurt.....	21
How to operate the grill.....	21
Cooking times table for grilling.....	21

7 Maintenance and care 22

General information.....	22
Cleaning the hob	22
Cleaning the control panel	22
Cleaning the oven	22
Removing the oven door	23
Replacing the oven lamp.....	23

8 Troubleshooting 24

9 Consumer Services 25

1 Important instructions and warnings for safety and environment

This section contains safety instructions that will help protect from risk of personal injury or property damage. Failure to follow these instructions shall void any warranty.

General safety

- This appliance can be used by children aged from 8 years and above and persons with reduced physical, sensory or mental capabilities or lack of experience and knowledge if they have been given supervision or instruction concerning use of the appliance in a safe way and understand the hazards involved.

Children shall not play with the appliance. Cleaning and user maintenance shall not be made by children without supervision.

- If the product is handed over to someone else for personal use or second-hand use purposes, the user manual, product labels and other relevant documents and parts should be also given.
- Never place the product on a carpet-covered floor. Otherwise, lack of airflow beneath the product will cause electrical parts to overheat. This will cause problems with your product.

- Installation and repair procedures must always be performed by Authorized Service Agents. The manufacturer shall not be held responsible for damages arising from procedures carried out by unauthorized persons which may also void the warranty. Before installation, read the instructions carefully.
- Do not operate the product if it is defective or has any visible damage.
- Ensure that the product function knobs are switched off after every use.

Safety when working with gas

- Any works on gas equipment and systems may only be carried out by authorised qualified persons who are Gas Safe registered.
- Prior to the installation, ensure that the local distribution conditions (nature of the gas and gas pressure) and the adjustment of the appliance are compatible.
- This appliance is not connected to a combustion products or evacuation device. It shall be installed and connected in accordance with current installation regulations. Particular attention shall be given to the relevant re-

quirements regarding ventilation;
See *Before installation, page 13*

- The use of gas cooking appliance results in the production of heat and moisture in the room in which it is installed. Ensure that the kitchen is well ventilated: keep natural ventilation holes open or install a mechanical ventilation device (mechanical extractor hood). Prolonged intensive use of the appliance may call for additional ventilation, for example increasing the level of the mechanical ventilation where present.
- Gas appliances and systems must be regularly checked for proper functioning. Regulator, hose and its clamp must be checked regularly and replaced within the periods recommended by its manufacturer or when necessary.
- Clean the gas burners regularly. The flames should be blue and burn evenly.
- Good combustion is required in gas appliances. In case of incomplete combustion, carbon monoxide (CO) might develop. Carbon monoxide is a colourless, odourless and very toxic gas, which has a lethal effect even in very small doses.
- Request information about gas emergency telephone numbers and safety measures in case of

gas smell from you local gas provider.

What to do when you smell gas

- Do not use open flame or do not smoke. Do not operate any electrical buttons (e.g. lamp button, door bell and etc.) Do not use fixed or mobile phones. Risk of explosion and toxication!
- Open doors and windows.
- Turn off all valves on gas appliances and gas meter at the main control valve, unless it's in a confined space or cellar.
- Check all tubes and connections for tightness. If you still smell gas leave the property.
- Warn the neighbours.
- Call the fire-brigade. Use a telephone outside the house.
- Do not re-enter the property until you are told it is safe to do so.

Electrical safety

- If the product has a failure, it should not be operated unless it is repaired by an Authorized Service Agent. There is the risk of electric shock!
- Only connect the product to a grounded outlet/line with the voltage and protection as specified in the "Technical specifications". Have the grounding installation made by a qualified electrician while using the product with or without a transformer. Our com-

pany shall not be liable for any problems arising due to the product not being earthed in accordance with the local regulations.

- Never wash the product by spreading or pouring water onto it! There is the risk of electric shock!
- Never touch the plug with wet hands! Never unplug by pulling on the cable, always pull out by holding the plug.
- The product must be disconnected during installation, maintenance, cleaning and repairing procedures.
- If the power connection cable for the product is damaged, it must be replaced by the manufacturer, its service agent or similarly qualified persons in order to avoid a hazard.
- The appliance must be installed so that it can be completely disconnected from the mains supply. The separation must be provided by a switch built into the fixed electrical installation, according to construction regulations.
- Rear surface of the oven gets hot when it is in use. Make sure that the gas/electrical connection does not contact the rear surface; otherwise, connections can get damaged.
- Do not trap the mains cable between the oven door and frame

and do not route it over hot surfaces. Otherwise, cable insulation may melt and cause fire as a result of short circuit.

- Any work on electrical equipment and systems should only be carried out by authorized and qualified persons.
- In case of any damage, switch off the product and disconnect it from the mains. To do this, turn off the fuse at home.
- Make sure that fuse rating is compatible with the product.

Product safety

- The appliance and its accessible parts become hot during use. Care should be taken to avoid touching heating elements. Children less than 8 years of age shall be kept away unless continuously supervised.
- Never use the product when your judgment or coordination is impaired by the use of alcohol and/or drugs.
- Be careful when using alcoholic drinks in your dishes. Alcohol evaporates at high temperatures and may cause fire since it can ignite when it comes into contact with hot surfaces.
- Food Poisoning Hazard: Do not let food sit in oven for more than 1 hour before or after cooking. Do-

ing so can result in food poisoning or sickness.

- Do not place any flammable materials close to the product as the sides may become hot during use.
- During use the appliance becomes hot. Care should be taken to avoid touching heating elements inside the oven.
- Keep all ventilation slots clear of obstructions.
- Do not heat closed tins and glass jars in the oven. The pressure that would build-up in the tin/jar may cause it to burst.
- Do not place baking trays, dishes or aluminium foil directly onto the bottom of the oven. The heat accumulation might damage the bottom of the oven.
- Do not use harsh abrasive cleaners or sharp metal scrapers to clean the oven door glass since they can scratch the surface, which may result in shattering of the glass.
- Do not use steam cleaners to clean the appliance as this may cause an electric shock.
- Placing the wire shelf and tray onto the wire racks properly
It is important to place the wire shelf and/or tray onto the rack properly. Slide the wire shelf or tray between 2 rails and make sure that it is balanced before

placing food on it (Please see the following figure).

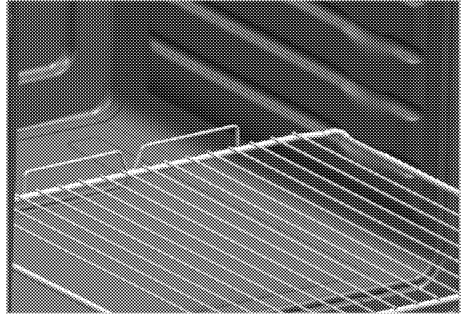

- Do not use the product if the front door glass removed or cracked.
- Do not use the oven handle to hang towels for drying. Do not hang up towel, gloves, or similar textile products when the grill function is at open door.
- Always use heat resistant oven gloves when putting in or removing dishes into/from the hot oven.
- Place the baking paper into the cooking pot or on to the oven accessory (tray, wire grill etc) together with the food and then insert all into the preheated oven. Remove the excess parts of the baking paper overflowing from the accessory or the pot in order to prevent the risk of touching the oven's heating elements. Never use the baking paper in an operating temperature higher than the indicated value for the baking paper. Do not place the baking paper directly on the base of the oven.

- Ensure that the appliance is disconnected from mains before replacing the lamp to avoid the possibility of electric shock.
- Do not close the top cover before the hotplates or burners cool down.
Wipe the top cover dry before opening it in order to avoid water leakage to the rear and inner sections of the oven.
- Unattended cooking on a hob with fat or oil can be dangerous and may result in fire. NEVER try to extinguish a fire with water, but switch off the appliance and then cover flame e.g. with a lid or a fire blanket.
- Danger of fire: Do not store items on the cooking surfaces.

Prevention against possible fire risk!

- Ensure all electrical connections are secure and tight to prevent risk of arcing.
- Do not use damaged cables or extension cables.
- Ensure liquid or moisture is not accessible to the electrical connection point.
- To prevent gas leakage ensure that the gas connection is sound.

Intended use

- This product is designed for domestic use. Commercial use will void the guarantee.

- This appliance is for cooking purposes only. It must not be used for other purposes, for example room heating.
- This product should not be used for warming the plates under the grill, drying towels, dish cloths etc. by hanging them on the oven door handles. This product should also not be used for room heating purposes.
- The manufacturer shall not be liable for any damage caused by improper use or handling errors.
- The oven can be used for defrosting, baking, roasting and grilling food.
- Service life of your product is 10 years. Manufacturer shall provide the required spare parts for the product to perform as defined during this period.

Safety for children

- Accessible parts may become hot during use. Young children should be kept away.
- The packaging materials will be dangerous for children. Keep the packaging materials away from children. Please dispose of all parts of the packaging according to environmental standards.
- Electrical and/or gas products are dangerous to children. Keep children away from the product when

it is operating and do not allow them to play with the product.

- Do not place any items above the appliance that children may reach for.
- When the door is open, do not load any heavy object on it and do not allow children to sit on it. It may overturn or door hinges may get damaged.

Compliance with AEEE regulation and disposal of waste products

- This product does not contain harmful and forbidden materials described in the "Directive on the Restriction of the Use of Certain Hazardous Substances in Waste Electrical and Electronic Equipment" (AEEE) issued by the T.R. Ministry of Environment and Urbanization. Complies with the AEEE Directive.



- This product has been manufactured with high quality parts and materials which can be reused and are suitable for recycling. Therefore, do not dispose the product with normal

domestic waste at the end of its service life. Take it to a collection point for the recycling of electrical and electronic equipment. Please consult your local authorities to learn the nearest collection point. Help protect the environment and natural resources by recycling used products. Before disposing of the product, cut off the power cable plug and make the door lock (if any) unusable to avoid dangerous conditions to children.

Package information

- Packaging materials of the product are manufactured from recyclable materials in accordance with our National Environment Regulations. Do not dispose of the packaging materials together with the domestic or other wastes. Take them to the packaging material collection points designated by the local authorities.

2 General information

Overview

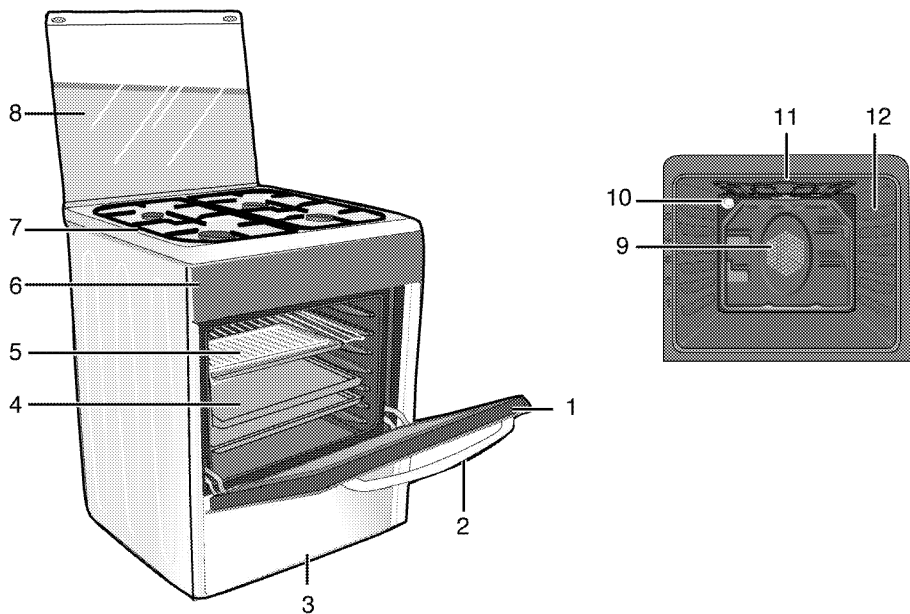

- 1 Front door
- 2 Handle
- 3 Bottom drawer
- 4 Tray
- 5 Wire shelf
- 6 Control panel

- 7 Burner plate
- 8 Top lid
- 9 Fan motor (behind steel plate)
- 10 Lamp
- 11 Grill heating element
- 12 Shelf positions

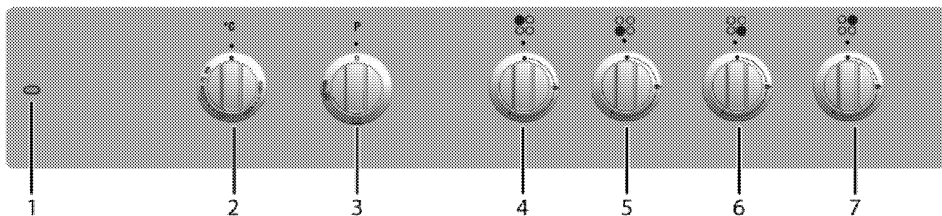

- 1 Thermostat lamp
- 2 Thermostat knob
- 3 Function knob
- 4 Normal burner Rear left

- 5 Rapid burner Front left
- 6 Auxiliary burner Front right
- 7 Normal burner Rear right

Package contents



Accessories supplied can vary depending on the product model. Not every accessory described in the user manual may exist on your product.

1. **User manual**

2. **Oven tray**

Used for pastries, frozen foods and big roasts.

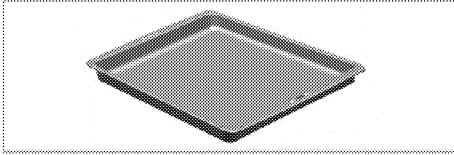

3. **Deep tray**

Used for pastries, large roasts, juicy dishes, and for collecting the fat while grilling.

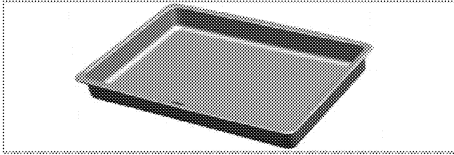

4. **Wire Shelf**

Used for roasting and for placing the food to be baked, roasted or cooked in casserole dishes to the desired rack.

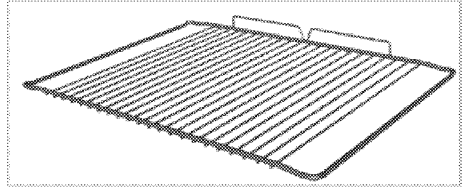

5. **Coffee pot adaptor**



Used for coffe pots.

Technical specifications

GENERAL	
External dimensions (height / width / depth)	850 mm/600 mm/600 mm
Voltage / frequency	220-240 V ~ 50 Hz
Total power consumption	2.2 kW
Fuse	min. 16 A
Cable type / section	min.H05VV-FG 3 x 1 mm ²
Category of gas product	II 2H3B/P
Gas type / pressure	LPG G 30/28-30 mbar
Total gas consumption	7.9 kW
Converting the gas type / pressure ^S	NG G 20/20 mbar
– optional	
HOB	
Burners	
Rear left	Normal burner
Power	2 kW
Front left	Rapid burner
Power	2.9 kW
Front right	Auxiliary burner
Power	1 kW
Rear right	Normal burner
Power	2 kW
OVEN/GRILL	
Main oven	Fan oven
Inner lamp	15–25 W
Grill power consumption	2.2 kW

* Basics: Information on the energy label of electrical ovens is given in accordance with the EN 60350-1 / IEC 60350-1 standard. Those values are determined under standard load with bottom-top heater or fan assisted heating (if any) functions.

Energy efficiency class is determined in accordance with the following prioritization depending on whether the relevant functions exist on the product or not. 1-Cooking with eco-fan, 2- Turbo slow cooking, 3- Turbo cooking, 4- Fan assisted bottom/top heating, 5-Top and bottom heating.



Technical specifications may be changed without prior notice to improve the quality of the product.



Figures in this manual are schematic and may not exactly match your product.





Values stated on the product labels or in the documentation accompanying it are obtained in laboratory conditions in accordance with relevant standards. Depending on operational and environmental conditions of the product, these values may vary.

3 Installation

Refer to the nearest Authorised Service Agent for installation of the product. Make sure that the electric and gas installations are in place before calling the Authorised Service Agent to have the product ready for operation. If not, call a qualified electrician and fitter to have the required arrangements made. The manufacturer shall not be held responsible for damages arising from procedures carried out by unauthorized persons which may also void the warranty.

 Preparation of location and electrical and gas installation for the product is under customer's responsibility.

 **DANGER:**
The product must be installed in accordance with all local gas and/or electrical regulations.

 **DANGER:**
Prior to installation, visually check if the product has any defects on it. If so, do not have it installed.
Damaged products cause risks for your safety.

Before installation

To ensure that critical air gaps are maintained under the appliance, we recommend that this appliance is mounted on a solid base and that the feet do not sink into any carpet or soft flooring.

The kitchen floor must be able to carry the weight of the appliance plus the additional weight of cookware and bakeware and food.

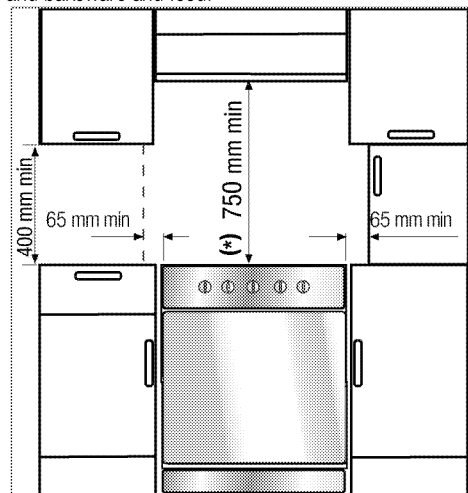

- It can be used with cabinets on either side but in order to have a minimum distance of 400mm

above hotplate level allow a side clearance of 65mm between the appliance and any wall, partition or tall cupboard.

- It can also be used in a free standing position. Allow a minimum distance of 750 mm above the hob surface.
- (*) If a cooker hood is to be installed above the cooker, refer to cooker hood manufacturer' instructions regarding installation height (min 650 mm).
- The appliance corresponds to device class 1, i.e. it may be placed with the rear and **one** side to kitchen walls, kitchen furniture or equipment of any size. The kitchen furniture or equipment on the **other** side may only be of the same size or smaller.
- Any kitchen furniture next to the appliance must be heat-resistant (100 °C min.).

 **LP Gas Only**
Don't install this appliance in a room below ground level unless it is oven to ground level on at least one side.
Failure to install appliances correctly is dangerous and could result in prosecution.

Safety chain

The appliance must be secured against overbalancing by using the supplied two safety chains on your oven. Fasten hook (1) by using a proper peg to the kitchen wall (6) and connect safety chain (3) to the hook via the locking mechanism (2).

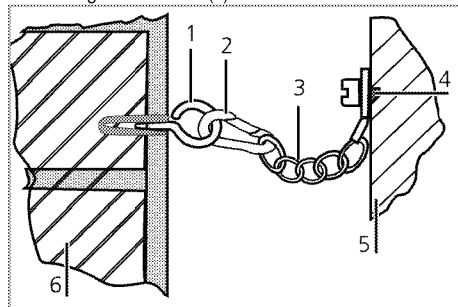

- 1 Stability hook
- 2 Locking mechanism
- 3 Safety chain (supplied and mounted to oven)
- 4 Firmly fix chain to cooker rear
- 5 Rear of cooker
- 6 Kitchen wall



Stability chain to be as short as practicable to avoid oven tilting forward and diagonal to avoid oven side tilting.

Cooker stability chain for cookers not designed with bracket engagement slot.

Room ventilation

All rooms require an openable window, or equivalent, and some rooms will require a permanent vent as well. The air for combustion is taken from the room air and the exhaust gases are emitted directly into the room. Good room ventilation is essential for safe operation of your appliance. If there is no window or door available for room ventilation, an extra ventilation must be installed.

The appliance may be located in a kitchen, kitchen/diner or a bed-sitting room, but not in a room containing a bath or shower. The appliance must not be installed in a bed-sitting room of less than 20m³. Do not install this appliance in a room below ground level unless it is open to ground level on at least one side.

Room size	Ventilation opening
smaller than 5 m ³	min. 100 cm ²
5 m ³ to 10 m ³	min. 50 cm ²
greater than 10 m ³	not required
In the cellar or basement	min. 65 cm ²

Installation and connection

Product can only be installed and connected in accordance with the statutory installation rules.



Do not install the product next to refrigerators or freezers. The heat emitted by the product will increase the energy consumption of cooling appliances.

- Carry the product with at least two persons.
- Product must be placed directly on the floor. It must not be placed onto a base or a pedestal.



Do not use the door and/or handle to carry or move the product. The door, handle or hinges get damaged.

Electrical connection

Connect the product to a grounded outlet/line protected by a fuse of suitable capacity as stated in the "Technical specifications" table. Have the grounding installation made by a qualified electrician while using the product with or without a transformer. Our com-

pany shall not be liable for any damages that will arise due to using the product without a grounding installation in accordance with the local regulations.



DANGER:

The product must be connected to the mains supply only by an authorised and qualified person. The product's warranty period starts only after correct installation.

Manufacturer shall not be held responsible for damages arising from procedures carried out by unauthorised persons.



DANGER:

The power cable must not be clamped, bent or trapped or come into contact with hot parts of the product.

A damaged power cable must be replaced by an Authorised Service Agent. Otherwise, there is risk of electric shock, short circuit or fire!

The mains supply data must correspond to the data specified on the type label of the product. The rating plate is either seen when the door or the lower cover is opened or it is located at the rear wall of the unit depending on the unit type.

Power cable of your product must comply with the values in "Technical specifications" table.



Power cable plug must be within easy reach after installation (do not route it above the hob).



DANGER:

Before starting any work on the electrical installation, disconnect the product from the mains supply.

There is the risk of electric shock!

Connect the power cable into the socket.

Gas connection



DANGER:

Product can be connected to gas supply system only by an authorised and qualified person or technician with licence.

Risk of explosion or toxication due to unprofessional repairs!

Manufacturer shall not be held responsible for damages arising from procedures carried out by unauthorised or unlicensed persons.



DANGER:

Before starting any work on the gas installation, disconnect the gas supply.

There is the risk of explosion!

- Gas adjustment conditions and values are stated on labels (or on type label).



Your product is equipped for liquefied petroleum gas (LPG).

Connecting the gas hose

- Have your product connected in a way that it will be close to the gas connection and not gas leakage will exist.
- Plastic hose to be used must not be longer than 125 cm.
- Install the clamp to the hose. Soak one end of the hose (15 mm inner diameter) into boiling water for one minute to soften it.
- Then, slip the softened end of the hose completely onto the sharp hose tip of your product. Finally, tighten the clamp completely with a screwdriver.
- Repeat the same procedure for the other end of the hose and complete the gas cylinder connection.
- Never forget to make the gas leakage control.



DANGER:

Risk of explosion and suffocation!
Do not keep LPG cylinders in home.

- If you need to use your product later with a different type of gas, you must consult the Authorised Service Agent for the related conversion procedure.

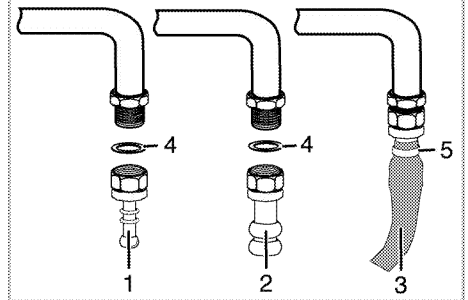
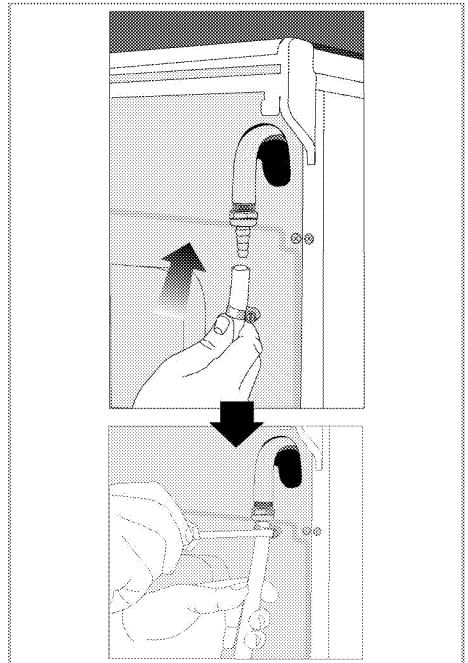

- 1 Hose tip-LPG
- 2 Hose tip-NG
- 3 Safety hose
- 4 O-ring (gasket)
- 5 Clamp

Leakage control at the connection point

- Make sure that all knobs on the product are turned off. Make sure that the gas supply is open. Prepare soapy foam and apply it onto the connection point of the hose for gas leakage control.
- Soapy part will froth if there is a gas leakage. In this case, inspect the gas connection once again.

 Never use a match or lighter to make the gas leakage control.

 **DANGER:**
The gas hose must not be clamped, bent or trapped or come into contact with hot parts of the product.
There is the risk of explosion due to damaged gas hose.

- Push the product towards the kitchen wall.
- **Adjusting the feet of oven**
Vibrations during use may cause cooking vessels to move. This dangerous situation can be avoided if the product is level and balanced.
For your own safety please ensure the product is level by adjusting the four feet at the bottom by turning left or right and align level with the work top.

Final check

1. Check electrical functions.
2. Open gas supply.
3. Check gas installations for secure fitting and tightness.
4. Ignite burners and check appearance of the flame.

 Flame must be blue and have a regular shape. If the flame is yellowish, check if the burner cap is seated securely or clean the burner.

Future Transportation

- Keep the product's original carton and transport the product in it. Follow the instructions on the carton. If you do not have the original carton, pack the product in bubble wrap or thick cardboard and tape it securely.
- To prevent the wire grill and tray inside the oven from damaging the oven door, place a strip of cardboard onto the inside of the oven door that lines up with the position of the trays. Tape the oven door to the side walls.
- Secure the caps and pan supports with adhesive tape.
- Do not use the door or handle to lift or move the product.

 Do not place any objects onto the product and move it in upright position.

 Check the general appearance of your product for any damages that might have occurred during transportation.

4 Preparation

Tips for saving energy

The following information will help you to use your appliance in an ecological way, and to save energy:

- Use dark coloured or enamel coated cookware in the oven since the heat transmission will be better.
- While cooking your dishes, perform a preheating operation if it is advised in the user manual or cooking instructions.
- Do not open the door of the oven frequently during cooking.
- Try to cook more than one dish in the oven at the same time whenever possible. You can cook by placing two cooking vessels onto the wire shelf.
- Cook more than one dish one after another. The oven will already be hot.
- You can save energy by switching off your oven a few minutes before the end of the cooking time. Do not open the oven door.
- Defrost frozen dishes before cooking them.
- Use pots/pans with cover for cooking. If there is no cover, energy consumption may increase 4 times.
- Select the burner which is suitable for the bottom size of the pot to be used. Always select the correct pot size for your dishes. Larger pots require more energy.

Initial use

First cleaning of the appliance



The surface might get damaged by some detergents or cleaning materials.

Do not use aggressive detergents, cleaning powders/creams or any sharp objects during cleaning.

Do not use harsh abrasive cleaners or sharp metal scrapers to clean the oven door glass since they can scratch the surface, which may result in shattering of the glass.

1. Remove all packaging materials.

2. Wipe the surfaces of the appliance with a damp cloth or sponge and dry with a cloth.

Initial heating

Heat up the product for about 30 minutes and then switch it off. Thus, any production residues or layers will be burnt off and removed.



WARNING

Hot surfaces cause burns!

Product may be hot when it is in use. Never touch the hot burners, inner sections of the oven, heaters and etc. Keep children away. Always use heat resistant oven gloves when putting in or removing dishes into/from the hot oven.

Electric oven

1. Take all baking trays and the wire grill out of the oven.
2. Close the oven door.
3. Select the highest oven power; See *How to operate the electric oven, page 19*.
4. Operate the oven for about 30 minutes.
5. Turn off your oven; See *How to operate the electric oven, page 19*

Grill oven

1. Take all baking trays and the wire grill out of the oven.
2. Close the oven door.
3. Select the highest grill power; see *How to operate the grill, page 21*.
4. Operate the grill about 30 minutes.
5. Turn off your grill; see *How to operate the grill, page 21*



Smoke and smell may emit for a couple of hours during the initial operation. This is quite normal. Ensure that the room is well ventilated to remove the smoke and smell. Avoid directly inhaling the smoke and the smell that emits.

5 How to use the hob

General information about cooking



Never fill the pan with oil more than one third of it. Do not leave the hob unattended when heating oil. Overheated oils bring risk of fire. **Never attempt to extinguish a possible fire with water!** When oil catches fire, cover it with a fire blanket or damp cloth. Turn off the hob if it is safe to do so and call the fire department.

- Before frying foods, always dry them well and gently place into the hot oil. Ensure complete thawing of frozen foods before frying.
- Do not cover the vessel you use when heating oil.
- Place the pans and saucepans in a manner so that their handles are not over the hob to prevent heating of the handles. Do not place unbalanced and easily tilting vessels on the hob.
- Do not place empty vessels and saucepans on cooking zones that are switched on. They might get damaged.
- Operating a cooking zone without a vessel or saucepan on it will cause damage to the product. Turn off the cooking zones after the cooking is complete.
- As the surface of the product can be hot, do not put plastic and aluminum vessels on it. Such vessels should not be used to keep foods either.
- Use flat bottomed saucepans or vessels only.
- Put appropriate amount of food in saucepans and pans. Thus, you will not have to make any unnecessary cleaning by preventing the dishes from overflowing.

Do not put covers of saucepans or pans on cooking zones.

Place the saucepans in a manner so that they are centered on the cooking zone. When you want to move the saucepan onto another cooking zone, lift and place it onto the cooking zone you want instead of sliding it.

Gas cooking

- Size of the vessel and the flame must match each other. Adjust the gas flames so that they will not extend the bottom of the vessel and center the vessel on saucepan carrier.

Using the hobs

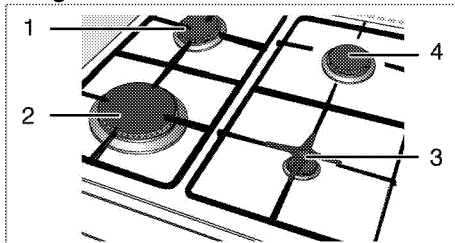

- 1 Normal burner 18-20 cm
- 2 Rapid burner 22-24 cm
- 3 Auxiliary burner 12-18 cm
- 4 Normal burner 18-20 cm is list of advised diameter of pots to be used on related burners.

Large flame symbol indicates the highest cooking power and small flame symbol indicates the lowest cooking symbol. In turned off position (top), gas is not supplied to the burners.

Igniting the gas burners

1. Keep burner knob pressed.
2. Turn it counter clockwise to large flame symbol.
» Gas is ignited with the spark created.
3. Adjust it to the desired cooking power.

Turning off the gas burners

Turn the keep warm zone knob to off (upper) position.

Gas shut off safety system (in models with thermic component)

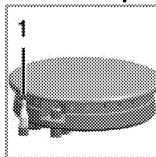

As a counter measure against blow out due to fluid overflows at burners, safety mechanism trips and shuts off the gas.

1. Gas shut off safety

- Push the knob inwards and turn it counter clockwise to ignite.
- After the gas ignites, keep the knob pressed for 3-5 seconds more to engage the safety system.
- If the gas does not ignite after you press and release the knob, repeat the same procedure by keeping the knob pressed for 15 seconds.



DANGER:

Release the button if the burner is not ignited within 15 seconds.

Wait at least 1 minute before trying again. There is the risk of gas accumulation and explosion!

6 How to operate the oven

General information on baking, roasting and grilling



WARNING

Hot surfaces cause burns!
Product may be hot when it is in use. Never touch the hot burners, inner sections of the oven, heaters and etc. Keep children away. Always use heat resistant oven gloves when putting in or removing dishes into/from the hot oven.



DANGER:

Be careful when opening the oven door as steam may escape.
Exiting steam can scald your hands, face and/or eyes.

Tips for baking

- Use non-sticky coated appropriate metal plates or aluminum vessels or heat-resistant silicone moulds.
- Make best use of the space on the rack.
- Place the baking mould in the middle of the shelf.
- Select the correct rack position before turning the oven or grill on. Do not change the rack position when the oven is hot.
- Keep the oven door closed.

Tips for roasting

- Treating whole chicken, turkey and large piece of meat with dressings such as lemon juice and black pepper before cooking will increase the cooking performance.
- It takes about 15 to 30 minutes longer to roast meat with bones when compared to roasting the same size of meat without bones.
- Each centimeter of meat thickness requires approximately 4 to 5 minutes of cooking time.
- Let meat rest in the oven for about 10 minutes after the cooking time is over. The juice is better distributed all over the roast and does not run out when the meat is cut.
- Fish should be placed on the middle or lower rack in a heat-resistant plate.

Tips for grilling

When meat, fish and poultry are grilled, they quickly get brown, have a nice crust and do not get dry. Flat pieces, meat skewers and sausages are particularly suited for grilling as are vegetables with high water content such as tomatoes and onions.

- Distribute the pieces to be grilled on the wire shelf or in the baking tray with wire shelf in such a way that the space covered does not exceed the size of the heater.
- Slide the wire shelf or baking tray with grill into the desired level in the oven. If you are grilling on the wire shelf, slide the baking tray to the lower rack to collect fats. Add some water in the tray for easy cleaning.



Foods that are not suitable for grilling carry the risk of fire. Only grill food which is suitable for intensive grilling heat.
Do not place the food too far in the back of the grill. This is the hottest area and fatty food may catch fire.

How to operate the electric oven

Select temperature and operating mode

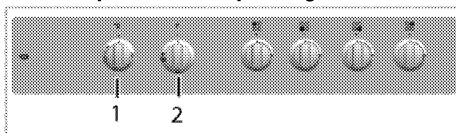

- 1 Thermostat knob
- 2 Function knob

1. Set the Function knob to the desired operating mode.
2. Set the Temperature knob to the desired temperature.

» Oven heats up to the adjusted temperature and maintains it. During heating, temperature lamp stays on.

Switching off the electric oven

Turn the function knob and temperature knob to off (upper) position.

Rack positions (For models with wire shelf)

It is important to place the wire shelf onto the side rack correctly. Wire shelf must be inserted between the side racks as illustrated in the figure.

Do not let the wire shelf stand against the rear wall of the oven. Slide your wire shelf to the front section of the rack and settle it with the help of the door in order to obtain a good grill performance.

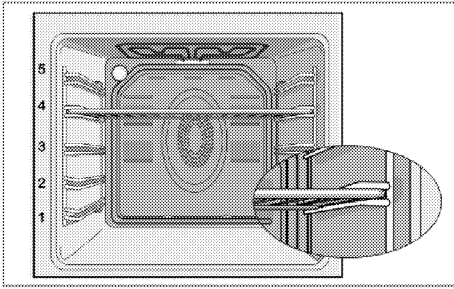

Operating modes

The order of operating modes shown here may be different from the arrangement on your product.

Fan Heating



Warm air heated by the rear heater is evenly distributed throughout the oven rapidly by means of the fan. It is suitable for cooking your meals in different rack levels and preheating is not required in most cases. Suitable for cooking with multi trays. This function must be used for easy steam cleaning as well.

Full grill



Large grill at the ceiling of the oven is in operation. It is suitable for grilling large amount of meat.

- Put big or medium-sized portions in correct rack position under the grill heater for grilling.
- Set the temperature to maximum level.
- Turn the food after half of the grilling time.

Cooking times table



The timings in this chart are meant as a guide. Timings may vary due to temperature of food, thickness, type and your own preference of cooking.

Baking and roasting



1st rack of the oven is the **bottom** rack.

Dish	Cooking level number		Rack position	Temperature (°C)	Cooking time (approx. in min.)
Cakes in tray*	One level		3	175	30 ... 40
Cakes in mould*	One level		2	175	45 ... 55
Cakes in cooking paper*	One level		3	175	25 ... 35
Sponge cake*	One level		3	200	8 ... 15
Cookies*	One level		3	175	25 ... 30
	2 levels		1 - 5	170 ... 180	35 ... 45
Dough pastry*	One level		3	200	35 ... 45
Rich pastry*	One level		3	200	25 ... 35
	2 levels		1 - 5	200	35 ... 45
Leaven*	One level		3	200	35 ... 45
Lasagna*	One level		3	200	30 ... 40
Beef steak (whole) / Roast	One level		3	25 min. 250/max, then 180 ... 190	100 ... 120
Leg of Lamb (casserole)	One level		3	25 min. 220 then 180 ... 190	70 ... 90
Roasted chicken	One level		2	15 min. 250/max, then 190	55 ... 65
Turkey (3-5 kg)	One level		1	25 min. 250/max, then 190	150 ... 210
Fish	One level		3	200	20 ... 30

When cooking with 2 trays at the same time, place the deeper tray on the upper rack and the other one on the lower rack.
 * It is suggested to perform preheating for all foods.

(**) In a cooking that requires preheating, preheat at the beginning of cooking until the thermostat lamp turns off.

Tips for baking cake

- If the cake is too dry, increase the temperature by 10°C and decrease the cooking time.

- If the cake is wet, use less liquid or lower the temperature by 10°C.
- If the cake is too dark on top, place it on a lower rack, lower the temperature and increase the cooking time.

- If cooked well on the inside but sticky on the outside use less liquid, lower the temperature and increase the cooking time.

Tips for baking pastry

- If the pastry is too dry, increase the temperature by 10°C and decrease the cooking time. Dampen the layers of dough with a sauce composed of milk, oil, egg and yoghurt.
- If the pastry takes too long to bake, pay care that the thickness of the pastry you have prepared does not exceed the depth of the tray.
- If the upper side of the pastry gets browned, but the lower part is not cooked, make sure that the amount of sauce you have used for the pastry is not too much at the bottom of the pastry. Try to scatter the sauce equally between the dough layers and on the top of pastry for an even browning.



Cook the pastry in accordance with the mode and temperature given in the cooking table. If the bottom part is still not browned enough, place it on one lower rack next time.

Tips for cooking vegetables

- If the vegetable dish runs out of juice and gets too dry, cook it in a pan with a lid instead of a tray. Closed vessels will preserve the juice of the dish.
- If a vegetable dish does not get cooked, boil the vegetables beforehand or prepare them like canned food and put in the oven.

Making yogurt

1. Add 100 gr (3-4 tablespoons) yogurt to 1000 ml of pasteurized milk at room temperature and mix well. Fill a glassware with the mixture.
2. Place the wire grill into the 2nd rack of the oven and place the glassware on it.
3. Set the thermostat and function button to  symbol. Keep the mixture in the oven for 5-7 hours until it is fermented.

4. For a sweet and less thicker yogurt keep the duration shorter and for a sour and thicker yogurt keep the duration longer.
5. When the process is over, it is recommended that the yghurt is consumed after being kept in the fridge (+4oC) for 12 hours.

Important Points:

- The most suitable milk for yogurt making is daily pasteurized milk.
- Milks that are raw and without heat treatment can also be used for yogurt making but they should be boiled in order to eliminate the pathogens/harmful microorganisms. The boiled milk should be cooled to room temperature before making yogurt.
- Sterilized long-life milks are not suitable for yogurt making, and they should not be used.
- The yogurt used for fermenting should be fresh.

How to operate the grill



WARNING

Close oven door during grilling.
Hot surfaces may cause burns!

Switching on the grill

1. Turn the Function knob to the desired grill symbol.
2. Then, select the desired grilling temperature.
3. If required, perform a preheating of about 5 minutes.

» Temperature light turns on.

Switching off the grill

1. Turn the Function knob to Off (top) position.



Foods that are not suitable for grilling carry the risk of fire. Only grill food which is suitable for intensive grilling heat.

Do not place the food too far in the back of the grill. This is the hottest area and fatty food may catch fire.

Cooking times table for grilling

Grilling with electric grill

Food	Insertion level	Grilling time (approx.)
Fish	4..5	20...25 min. #
Sliced chicken	4..5	25...35 min.
Lamb chops	4..5	20...25 min.
Roast beef	4..5	25...30 min. #
Veal chops	4..5	25...30 min. #
Toast bread	4	1...2 min.

depending on thickness

7 Maintenance and care

General information

Service life of the product will extend and the possibility of problems will decrease if the product is cleaned at regular intervals.

**DANGER:**

Disconnect the product from mains supply before starting maintenance and cleaning works.

There is the risk of electric shock!

**DANGER:**

Allow the product to cool down before you clean it.

Hot surfaces may cause burns!

- Clean the product thoroughly after each use. In this way it will be possible to remove cooking residues more easily, thus avoiding these from burning the next time the appliance is used.
- No special cleaning agents are required for cleaning the product. Use warm water with washing liquid, a soft cloth or sponge to clean the product and wipe it with a dry cloth.
- Always ensure any excess liquid is thoroughly wiped off after cleaning and any spillage is immediately wiped dry.
- Do not use cleaning agents that contain acid or chloride to clean the stainless or inox surfaces and the handle. Use a soft cloth with a liquid detergent (not abrasive) to wipe those parts clean, paying attention to sweep in one direction.
- Do not use solid metal scrapers or abrasive cleaning materials to clean the glass cover. Glass surface can get damaged.



The surface might get damaged by some detergents or cleaning materials.

Do not use aggressive detergents, cleaning powders/creams or any sharp objects during cleaning.

Do not use harsh abrasive cleaners or sharp metal scrapers to clean the oven door glass since they can scratch the surface, which may result in shattering of the glass.



Do not use steam cleaners to clean the appliance as this may cause an electric shock.

Cleaning the hob

Gas hobs

1. Remove and clean the saucepan carriers and burner caps.
2. Clean the hob.
3. Install the burner caps and make sure that they are seated correctly.
4. When installing the upper grills, pay attention to place the saucepan carriers so that the burners are centered.

Cleaning the control panel

Clean the control panel and knobs with a damp cloth and wipe them dry.



Do not remove the control buttons/knobs to clean the control panel.

Control panel may get damaged!

Cleaning the oven

Easy Steam Cleaning

It ensures easy cleaning because the dirt (having waited not for too long) is softened with the steam that forms inside the oven and the water drops condensing on the inner surfaces of the oven.

1. Remove all accessories inside the oven.
2. Place a metal container to the bottom of the oven. Add 400 ml water into the container.

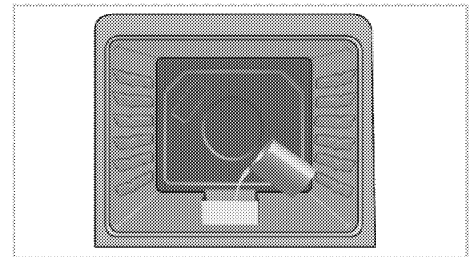

3. Set the oven to easy steam cleaning mode and run at 200°C for 25 minutes.
4. Open the door and wipe the inner surfaces of the oven with a damp sponge or cloth.
5. Use warm water with washing liquid, a soft cloth or sponge to clean the persistent dirt and wipe it with a dry cloth.

Clean oven door

To clean the oven door, use warm water with washing liquid, a soft cloth or sponge to clean the product and wipe it with a dry cloth.



Don't use any harsh abrasive cleaners or sharp metal scrapers for cleaning the oven door. They could scratch the surface and destroy the glass.

Removing the oven door

1. Open the front door (1).
2. Open the clips at the hinge housing (2) on the right and left hand sides of the front door by pressing them down as illustrated in the figure.

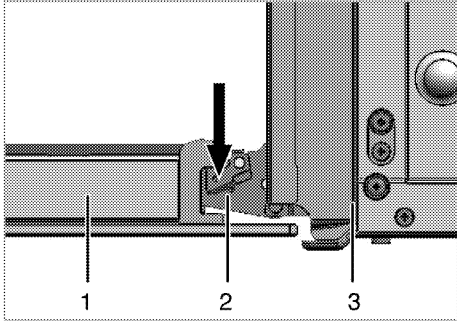

- 1 Front door
- 2 Hinge
- 3 Oven

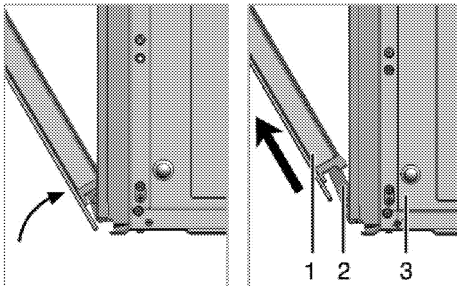

3. Move the front door to half-way.
4. Remove the front door by pulling it upwards to release it from the right and left hinges.



Steps carried out during removing process should be performed in reverse order to install the door. Do not forget to close the clips at the hinge housing when reinstalling the door.

Replacing the oven lamp



DANGER:

Before replacing the oven lamp, make sure that the product is disconnected from mains and cooled down in order to avoid the risk of an electrical shock.
Hot surfaces may cause burns!



The oven lamp is a special electric light bulb that can resist up to 300 °C. See *Technical specifications, page 12* for details. Oven lamps can be obtained from Authorised Service Agents or technician with licence.



Position of lamp might vary from the figure.



The lamp used in this appliance is not suitable for household room illumination. The intended purpose of this lamp is to assist the user to see foodstuffs.



The lamps used in this appliance have to withstand extreme physical conditions such as temperatures above 50 °C.

If your oven is equipped with a round lamp:

1. Disconnect the product from mains.
2. Turn the glass cover counter clockwise to remove it.

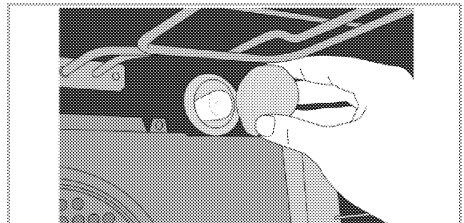

3. Remove the oven lamp by turning it counter clockwise and replace it with the new one.
4. Install the glass cover.

8 Troubleshooting

Oven emits steam when it is in use.

- It is normal that steam escapes during operation. >>> *This is not a fault.*

Product emits metal noises while heating and cooling.

- When the metal parts are heated, they may expand and cause noise. >>> *This is not a fault.*

Product does not operate.

- The mains fuse is defective or has tripped. >>> *Check fuses in the fuse box. If necessary, replace or reset them.*
- Product is not plugged into the (grounded) socket. >>> *Check the plug connection.*

Oven light does not work.

- Oven lamp is defective. >>> *Replace oven lamp.*
- Power is cut. >>> *Check if there is power. Check the fuses in the fuse box. If necessary, replace or reset the fuses.*

Oven does not heat.

- Function and/or Temperature are not set. >>> *Set the function and the temperature with the Function and/or Temperature knob/key.*
- Power is cut. >>> *Check if there is power. Check the fuses in the fuse box. If necessary, replace or reset the fuses.*

There is no ignition spark.

- No current. >>> *Check fuses in the fuse box.*

There is no gas.

- Main gas valve is closed. >>> *Open gas valve.*
- Gas pipe is bent. >>> *Install gas pipe properly.*

Burners are not burning properly or at all.

- Burners are dirty. >>> *Clean burner components.*
- Burners are wet. >>> *Dry the burner components.*
- Burner cap is not mounted safely. >>> *Mount the burner cap properly.*
- Gas valve is closed. >>> *Open gas valve.*
- Gas cylinder is empty (when using LPG). >>> *Replace gas cylinder.*



Consult the Authorised Service Agent or technician with licence or the dealer where you have purchased the product if you can not remedy the trouble although you have implemented the instructions in this section. Never attempt to repair a defective product yourself.

9 Consumer Services

Dear Valued Customer,

Arçelik Call Center provides services 24 hours, 7 days a week.

You can dial our call centre number without adding an area code from your mobile or fixed phones and ask for any service related with your product.

The calls you made to our call centre may be charged by your service provider based on your defined tariff.

You can also access our call centre by completing the form in "Consumer Services" section on the www.com.tr website or by sending a fax to 0216 423 23 53.

For correspondence, our address is:

Arçelik Çağrı Merkezi, Arçelik A.Ş. Ankara Asfaltı Yanı, 34950 Tuzla/İSTANBUL

Arçelik Call Centre

444 0 888

(Call the number without dialing the area code from your fixed or mobile phones)

Alternative Number

0216 585 8 888

Please follow the recommendations below.

- 1 When you purchase the product, have its Warranty Certificate approved by your Authorised Dealer.
- 2 Follow the instructions in user manual when using your product.
- 3 Please contact our Call Centre from the phone numbers above to submit your service request.
- 4 Please ask the service technician to present his/her "technician ID".
- 5 Do not forget to ask a "Service Receipt" from the technician when your job is completed. The "Service Receipt" you receive will be useful in case of any future problems related to your product.
- 6 Service life of the product is 10 years. (The manufacturer will provide spare parts during this period to ensure the product's operation)

Customer Satisfaction Policy

As Arçelik A.Ş., we adopt a customer oriented approach accepting the fact of providing superior customer experience without making any client profile discrimination by enabling the transmission of customer requests and suggestions for our brand that we provide service through all channels (call centre, e-mail, www.com.tr, facsimile, letter, social media, resellers), collecting these in a single traceable, reportable, transparent and reliable information repository, handling and evaluating these in an objective, fair and confidential way as per the legal regulations, and continuously checking and improving the processes. In line with our approach, all processes are integrated with the management system, a self-checking structure has been developed and also the management targets are fed through this system.

Evaluating the service request

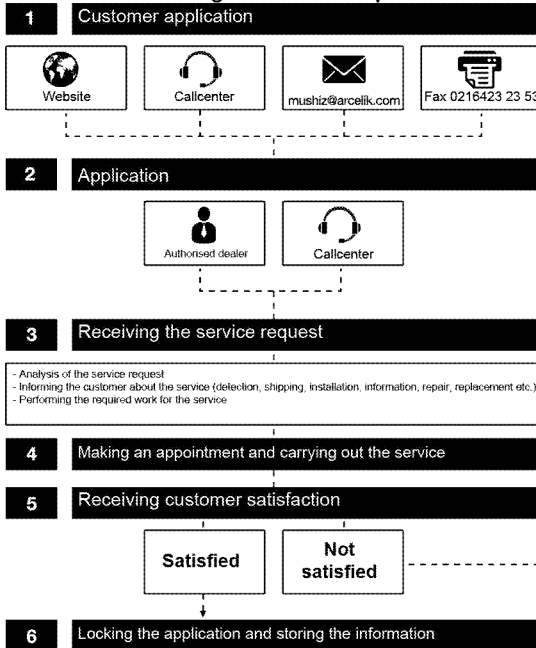

Usage Errors and Points to Take Into Consideration Regarding the Warranty

The issues specified below are remedied for a certain fee. The terms of warranty are not applied to these situations;

- 1) Damages and failures resulting from usage errors,*
- 2) Damages and failures emerged during loading, unloading, transportation etc. after the product has been delivered to the customer;*
- 3) Damages and failures resulting from the electricity, water, natural gas, telephone mains and/or network etc. or infrastructure where the product is being used,*
- 4) Damages and failures resulting from nature events, fire, floods etc.,*
- 5) Damages and failures resulting from using the product contrary to the points specified in the introduction and user manuals of the product,*
- 6) Damages and failures resulting from using the product with commercial or professional purposes as specified in the Law No. 6502 on Consumer Protection,*

The granted warranty will become void in the case that the product is maintained, repaired or interfered with any other purpose by unauthorised persons.

The warranty period of the product replaced within this period is limited to the remaining time of the previous product.

*Manufactured by Arçelik A.Ş.
Origin: Turkey*

Call Centre
444 0 888

The Other Number
0216 585 8 888

Arçelik A.Ş. Karaağaç Caddesi No:2-6,
34445, S  tl  ce / İSTANBUL
Tel.:(0-216) 585 85 85 Fax: (0-216) 423 23 53

CERTIFICATE OF WARRANTY

CERTIFICATE OF WARRANTY

- 1) The warranty period shall commence upon the delivery of the product and is specified as 3 years.
- 2) Starting from the delivery date, this warranty shall cover the whole product including all the parts incorporated for material, workmanship and manufacturing errors during the period specified above on the condition that the product has been used in accordance with the introductory and user manuals and has not been interfered for maintenance, repair or another purpose by persons other than those authorised by Arçelik A.Ş.
- 3) If the product is defective, in compliance with the clauses laid down in the Article 11 of the Law no. 6502 on Consumer Protection; the consumer shall become entitled to use one of the rights listed below:
- a- To cancel the contract,
b- To claim a deduction on the sale price,
c- To claim a free of charge repair,
d- To claim product replacement with a free of defects equivalent.
- 4) If the consumer prefers his/her right to get a free of charge repair; the seller shall be liable for repairing the product or have it repaired without charging any fees under the name of labour cost, replaced part cost or any other reason. Also, the consumer shall be able to use his/her right to get a free of charge repair against the manufacturer or the importer. The seller, the manufacturer and the importer shall be severally liable for the customer to use this right.
- 5) In the case that the consumer uses his/her right to get a free of charge repair; if:
- The product breaks down again within the warranty period,
- If the maximum duration required for repair is exceeded,
If the authorised service centre, the seller, the manufacturer or the importer designates the product as irreparable; the consumer shall be entitled to claim refund, deduction on the price in the ratio of the defect or a replacement with a free of defect equivalent, if present, from the seller.
The seller shall not have the right to reject the consumer's claim. The seller, the manufacturer and the importer shall be severally liable in the event that this claim has been rejected.
- 6) The maximum repair duration for the product cannot exceed 20 workdays during its service life specified in the relevant legislation. This period shall commence; on the date of submitting the failure of product to the authorised service centre or to the seller within the warranty period, or on the date of delivery of the product to the authorised service station out of the warranty period. If the product under warranty cannot be repaired within 10 workdays, the manufacturer or the importer shall; be obliged to assign another product with similar specifications to the consumer's use until the defective product is repaired. If the consumer does not demand another product with similar specifications, the manufacturer or the importers shall be released from this obligation. If the product breaks down within the warranty period, the down time shall be added to the warranty period.
- 7) Damages and failures resulting from using the product contrastively with the rules specified in the user manual are not covered by the warranty.
- 8) The consumer shall be able to go to the Consumer Arbitration Court or the Consumer Court found in the area where the place of residence is included or where the consumer processes are carried out in the case of disputes regarding the rights that come with the warranty.
- 9) If this certificate is not provided by the seller, the consumer shall have the right to refer to the Ministry of Customs and Trade Consumer Protection and the General Directorate of Market Surveillance.

Manufacturer's or Importer's:

Title: Arçelik A.Ş.
Address: Arçelik A.Ş. Karaağaç Caddesi No:2-6, 34445, Sıtlıce / İSTANBUL
Phone: (0-216) 585 8 888
Fax: (0-216) 423 23 53
web address: www.altus.com.tr

The Product's

Brand:
Type: Oven
Model:
Banderole and Serial No:
Warranty Period: 3 YEAR
Maximum Repair Duration: 20 Workdays

GENERAL MANAGER



DEPUTY GENERAL MANAGER

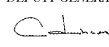

The Seller's:

Title:
Address:
Phone:
Fax :
e-mail:

Date and Number of Invoice:
Date and Place of Delivery:
Authorised Signature:
Company Seal:

The Authorised Seller who sold you the product shall sign and stamp this field.